

PALIO TRADE

by Karndean

LUXURY VINYL
FLOORING
FOR YOUR HOME



PICK ANY DESIGN IN UP TO 3 FITTING FORMATS



Palio Rigid

CLICK IT

Palio Rigid planks are joined by a click-locking mechanism



Palio LooseLay

LAY IT

Palio LooseLay planks and tiles are held in place by a friction grip backing



Palio Gluedown

STICK IT

Palio Gluedown planks are stuck down with adhesive



HAMDEN LLP156 | PVPI56*

CONTENTS

- WHAT IS PALIO TRADE BY KARNDÉAN? 4
- WHAT MAKES OUR FLOORS DIFFERENT? 6
- OUR COLLECTION WOOD AND STONE..... 7
- RANGE OVERVIEW AND BENEFITS 8
- CHOOSE YOUR FITTING FORMAT
- PALIO RIGID 10
- PALIO LOOSELAY 10
- PALIO GLUEDOWN 10
- FIND A STOCKIST 12
- SAMPLE SERVICE 13
- WOOD AT A GLANCE 14
- STONE AT A GLANCE 15
- WOOD 16
- STONE 26
- DESIGN IDEAS 28
- PALIO RIGID
- EASY FIT INSTALLATION GUIDELINES 30
- TECHNICAL SPECIFICATION 31
- PALIO LOOSELAY
- EASY FIT INSTALLATION GUIDELINES 32
- TECHNICAL SPECIFICATION 33
- PALIO GLUEDOWN 34
- TECHNICAL SPECIFICATION 35
- VERSILAY INSTASHIELD™ 36
- VERSILAY INSTASHIELD INSTALLATION INSTRUCTIONS™ 37
- COLOUR MATCHED SCOTIAS AND SKIRTING 38
- SCOTIA AND SKIRTING INSTALLATION GUIDELINES 39

WHAT IS PALIO TRADE BY KARNDEAN?

Palio Trade by Karndean luxury vinyl flooring is not like typical vinyl. It doesn't come in rolls or sheets, it comes in robust, pre-cut planks and tiles. Our highly realistic designs look just like the wood and stone materials they're inspired by with the following benefits:



WATERPROOF

Won't swell, crack or warp when wet.



DURABLE

The natural appearance of wood and stone but the durability and resilience of luxury vinyl.



LOW MAINTENANCE

Clean easily with a sweep and mop. No sanding, varnishing or staining.

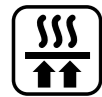

COMPATIBLE WITH UNDERFLOOR HEATING

Up to 27°C.



HIGHLY REALISTIC DESIGNS

Designed by Karndean's in-house product team to perfectly replicate real wood and stone.



SOFT, WARM AND QUIET UNDERFOOT

No cold tiles, no clicking shoes.



HYGIENIC

Unlike carpets, our floors don't hold dust, dirt, pollen or other allergens.



20 YEAR GUARANTEE

Designed to give you peace of mind with a 20 year residential guarantee.



BUDELLI PVP146-SCB | LLP146 | PVP146

WHAT MAKES OUR FLOORS DIFFERENT?

Palio Trade by Karndean is luxury vinyl flooring in a collection of contemporary designs, available in three fitting formats: rigid core, loose lay and gluedown.

Palio Trade by Karndean offers the flexibility to choose a colour no matter what fitting format is required. Whether you need to limit noise transfer between floors, or gain underfloor access after installation, Palio Trade by Karndean has a flooring solution for you.

Palio Rigid **CLICK IT**

Palio Rigid is our rigid core range that enables a quick installation due to its simple 2G™ click-locking mechanism and built in underlay. Its robust construction means it can be installed over most existing hard and uneven floors, without extensive subfloor preparation or the worry of imperfections appearing underfoot. Palio Rigid is a perfect choice for rooms above ground level. The acoustic backing, minimises sound transfer to room below by 19dB.

Palio LooseLay **LAY IT**

Our loose lay range, Palio LooseLay, features a friction grip backing that uses weight and friction to secure planks and tiles firmly in place. Where underfloor access post installation is required or, a plank or tile becomes damaged, Palio LooseLay can easily be lifted and replaced. Whats more, its quick and easy to install, fitting tight to walls and fixtures without the need to remove skirting boards or leave expansion gaps*.



TORCELLO PVP145-SCB | LLP145 | PVP145

Palio Gluedown **STICK IT**

Palio Gluedown is adhered to the subfloor and enables creativity with your floor. Mix and match designs, incorporate design strips for a bespoke floor unique to the interior**.

OUR COLLECTION

Our collection of 14 wood designs in a multiformat option enables you to carry the same colour through multiple spaces to cater for your flooring requirements. Our four versatile Palio LooseLay stone designs are the perfect choice for any traditional or modern interior.

WOOD SIZES



1211.2mm x 169.8mm

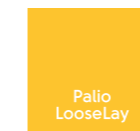

1050mm x 250mm

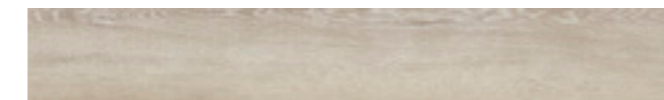
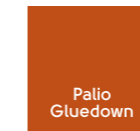

1219.2mm x 177.8mm

STONE SIZES

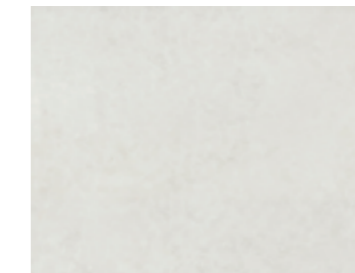
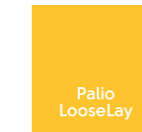

500mm x 610mm







* For rooms larger than 16m², tackifier is required. Please refer to palioflooring.com for installation instructions.

** Palio Gluedown can be installed with Versilay InstaShield™. See page 36 for more details or refer to palioflooring.com

RANGE OVERVIEW AND BENEFITS

PALIO RIGID





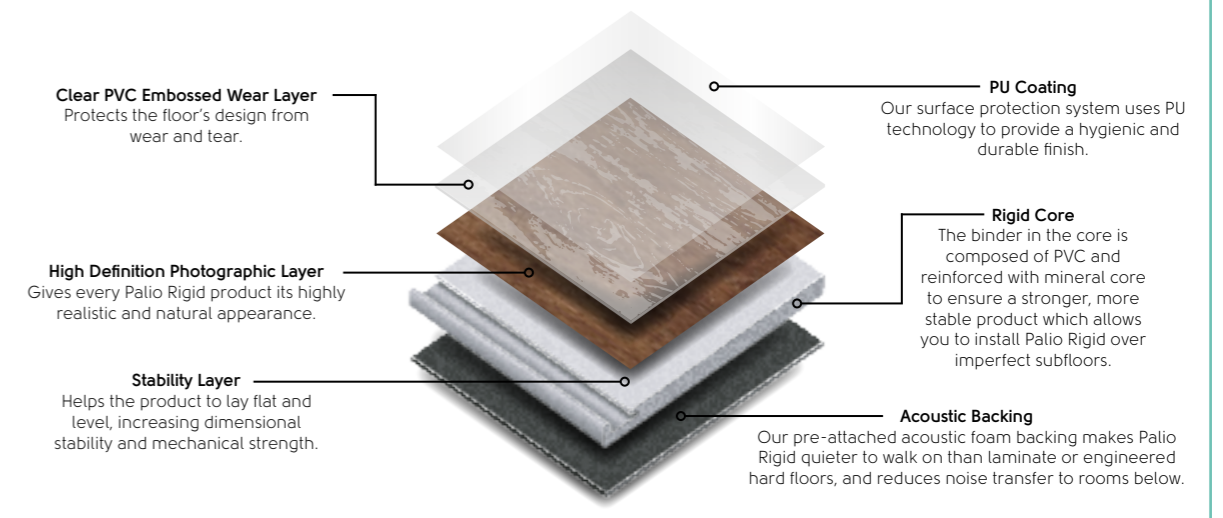

-  **PATENTED CLICK-LOCKING MECHANISM**
-  **QUICK AND EASY TO INSTALL**
-  **NO UNDERLAY REQUIRED**
-  **NO NEED FOR ADHESIVE**
-  **INSTALLS OVER MOST EXISTING HARD FLOORS**
-  **REDUCES IMPACT NOISE TRANSFER BY 19dB**



PALIO LOOSELAY



-  **FRICITION GRIP BACKING**
-  **QUICK AND EASY TO INSTALL**
-  **NO EXPANSION GAP**
-  **EASY TO REPLACE**
-  **REDUCES IMPACT NOISE TRANSFER BY 13dB**

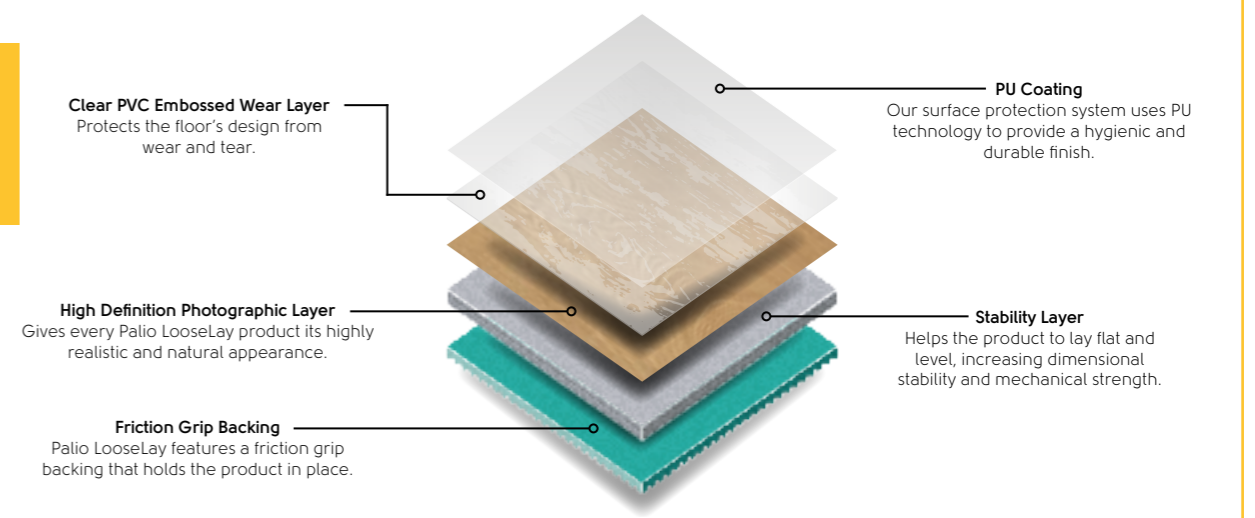

PALIO GLUEDOWN



-  **PROFESSIONAL INSTALLATION REQUIRED**
-  **ADHESIVE REQUIRED**
-  **PERSONALISE WITH DESIGN STRIPS**
-  **NO EXPANSION GAP**

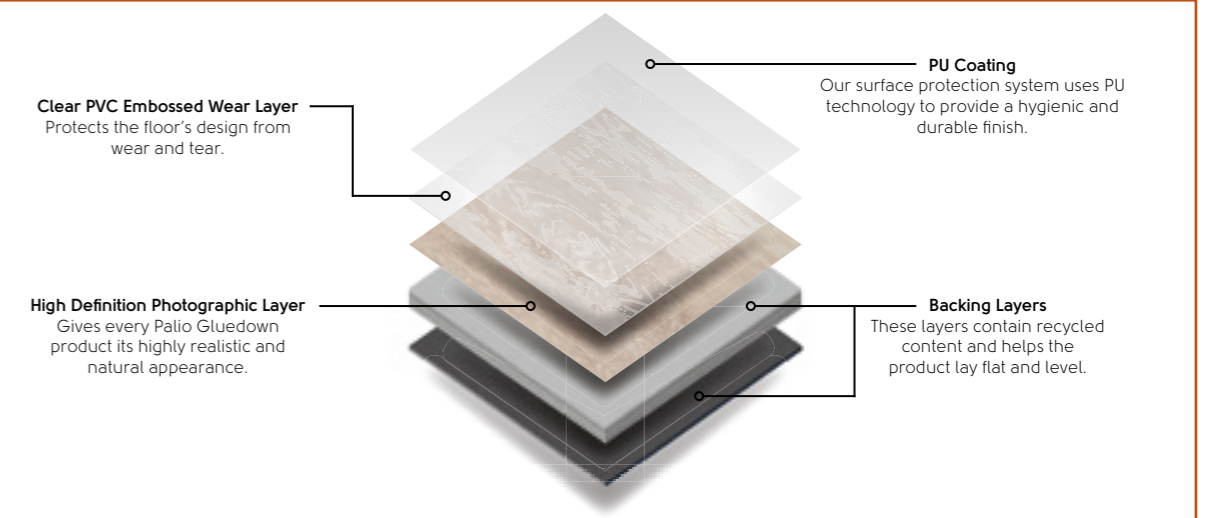





CHOOSE YOUR FITTING FORMAT

Choosing a fitting format that is right for you may depend on the subfloor you are laying your Palio floor onto. Our guide will help you identify the preferred subfloor finish for each product format.

Subfloor requirements for...	Flat: no undulations	Smooth	Level	Recommendation:
	X	X	Y	
	X	Y	Y	 
	Y	Y	Y	  







If you are choosing a floor based on a requirement, see our table below.

✓✓✓ Exceptional | ✓✓ Excellent | ✓ Good

Requirement				Recommendation
Speed of installation	✓✓	✓✓✓	✓	
Acoustics - reduces impact noise between building levels	✓✓✓	✓✓	✓	
Bespoke laying patterns	✓	✓✓	✓✓✓	
Install over existing hard floors with minimum preparation (i.e. ceramic tiles)	✓✓✓	✓✓	X	 
Suitable for stairs	X	X	✓✓✓	
Suitable for drying out subfloors i.e. new build	✓✓✓	✓✓✓	X	 
Install over uneven subfloors	✓✓✓	✓	X	
Preservation of existing subfloor	✓✓✓	✓	X	
Compatible alongside carpet tiles	X	✓✓✓	✓✓	
Easy to repair/replace a tile or planks	✓✓	✓✓✓	X	
Underfloor access after installation	X	✓✓✓	X	

CHOOSE PALIO RIGID WHEN...





Palio Rigid

-  You need a quick, simple installation with minimal downtime.
-  Your floor is still drying out such as new build developments.
-  You need superior acoustics between floors.
-  You are working on a historic building with structural limitations or preservation requirements.
-  You need to hide subfloor imperfections.
-  You need to install over an existing hard floor



CHOOSE PALIO LOOSELAY WHEN...



Palio LooseLay

-  You need a quick, simple installation with minimal downtime.
-  Your floor is still drying out such as new build developments.
-  You need superior acoustics between floors.
-  You need access to sub-floor utilities post-installation.



CHOOSE PALIO GLUEDOWN WHEN...

Palio Gluedown

-  You want to create a completely bespoke, unique floor.
-  The installation will be conducted by a specialist floor fitter.
-  You need to fit flooring flush to walls or skirting boards with no expansion gap.



FIND A STOCKIST

Our extensive network of Palio flooring stockists can help you make a selection. In branch you will find our product displays to browse our colours, designs and textures of each range on display and help you narrow down your choice.

Scan the QR code or visit palioflooring.com to locate your nearest stockist.

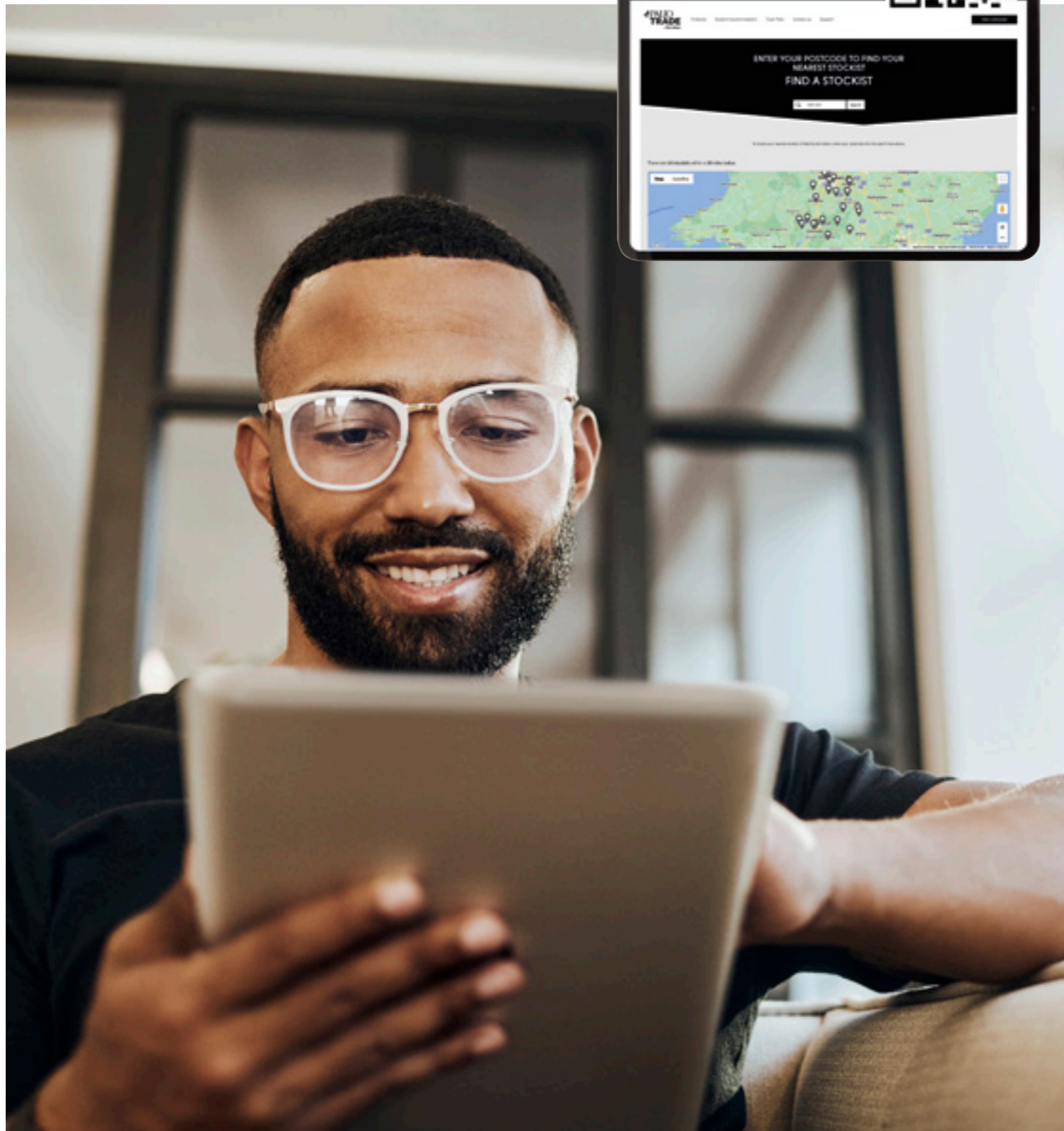

SAMPLE SERVICE

We provide a sample service to help you select which design is right for you. Order free chip samples to see in your surroundings alongside your furniture, fabrics and paint swatches to help you select the right Palio floor design.

FREE CHIP SAMPLES



To use our fast and convenient sample service visit palioflooring.com or call **01386 820110** to order your chip size samples.

WOOD AT A GLANCE



SALINA PVP161-SCB | LLP161 | PVP161



WATERBURY PVP152-SCB | LLP152 | PVP152



PALMARIA PVP149-SCB | LLP149 | PVP149



LAMPIONE PVP147-SCB | LLP147 | PVP147



SICILIA PVP142-SCB | LLP142 | PVP142

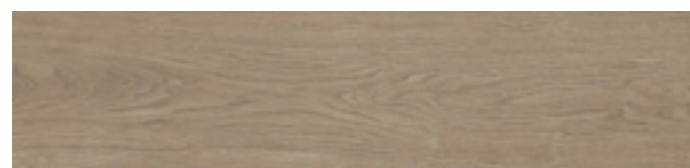

BUDELLI PVP146-SCB | LLP146 | PVP146



LINOSA PVP148-SCB | LLP148 | PVP148



BRIDGEPORT PVP157-SCB | LLP157 | PVP157



BROCKTON PVP153-SCB | LLP153 | PVP153



HAMDEN PVP156-SCB | LLP156 | PVP156



TAVOLARA PVP144-SCB | LLP144 | PVP144



TORCELLO PVP145-SCB | LLP145 | PVP145



LEVANZO PVP150-SCB | LLP150 | PVP150

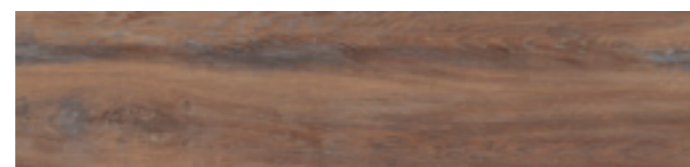

SARDINIA PVP143-SCB | LLP143 | PVP143

Palio Rigid

Size: 1211.2mm x 169.8mm
Thickness: 4.5mm
Wear Layer: 0.3mm
Box Quantity: 2.468m²

Palio LooseLay

Size: 1050mm x 250mm
Thickness: 4.5mm
Wear Layer: 0.55mm
Box Quantity: 3.150m²

Palio Gluedown

Size: 1219.2mm x 177.8mm
Thickness: 2.0mm
Wear Layer: 0.3mm
Box Quantity: 4.769m²

STONE AT A GLANCE



TINO LLT208



CAPRI LLT209

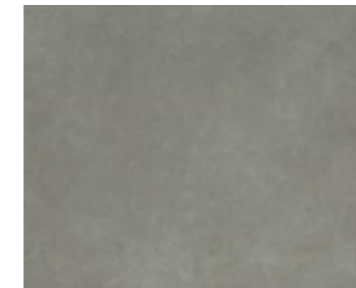

NISIDA LLT210

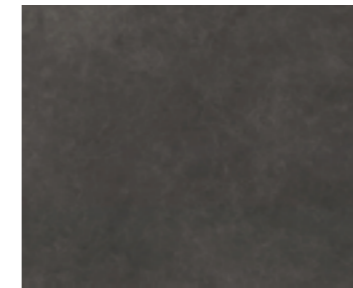

VULCANO LLT211

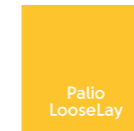

Size: 500mm x 610mm
Thickness: 4.5mm
Wear Layer: 0.55mm
Box Quantity: 3.050m²

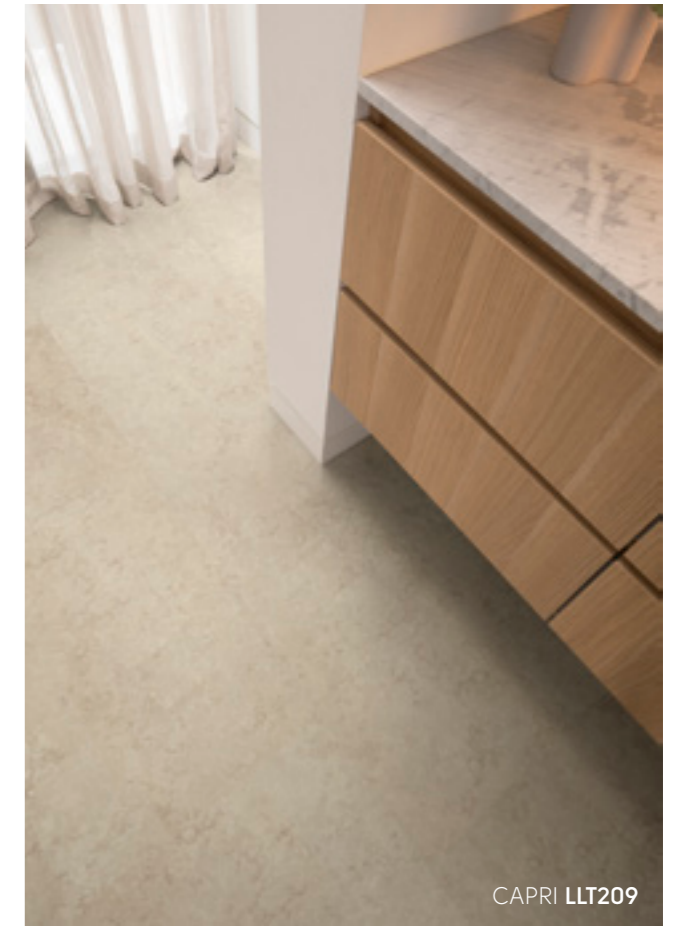

CAPRI LLT209



WATERBURY PVP152-SCB | LLP152 | PVP152

WOOD

- 1211.2mm x 169.8mm
- 1050mm x 250mm
- 1219.2mm x 177.8mm



SALINA
PVPI61-SCB | LLP161 | PVP161



BRIDGEPORT
PVPI57-SCB | LLP157 | PVP157



WATERBURY
PVPI52-SCB | LLP152 | PVP152



Replicating the look and feel of the natural materials they are inspired by without the practical drawbacks.

SALINA PVPI61-SCB | LLP161 | PVP161



BROCKTON PVP153-SCB | LLP153 | PVP153

WOOD

■ 1211.2mm x 169.8mm | ■ 1050mm x 250mm | ■ 1219.2mm x 177.8mm

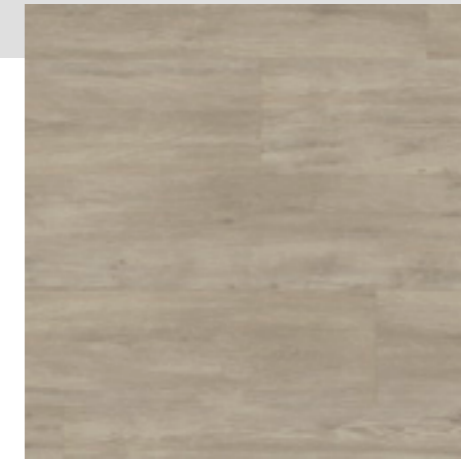

BROCKTON
PVP153-SCB | LLP153 | PVP153



PALMARIA
PVP149-SCB | LLP149 | PVP149



PALMARIA PVP149-SCB | LLP149 | PVP149

WOOD

■ 1211.2mm x 169.8mm

■ 1050mm x 250mm

■ 1219.2mm x 177.8mm



HAMDEN

PVPI56-SCB | LLP156 | PVP156



TAVOLARA

PVPI44-SCB | LLP144 | PVP144

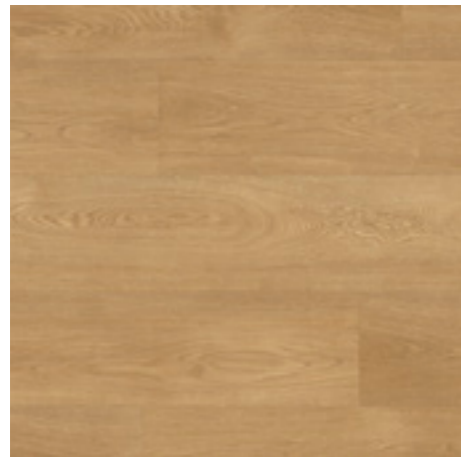

TORCELLO

PVPI45-SCB | LLP145 | PVP145

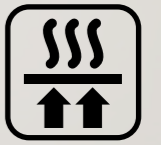

Palio floors are naturally warmer than wood or stone but are also compatible with underfloor heating up to 27°C.

TAVOLARA PVPI44-SCB | LLP144 | PVP144

WOOD

■ 1211.2mm x 169.8mm | ■ 1050mm x 250mm | ■ 1219.2mm x 177.8mm



LAMPIONE
PVP147-SCB | LLP147 | PVP147

SICILIA
PVP142-SCB | LLP142 | PVP142



LAMPIONE PVP147-SCB | LLP147 | PVP147



SICILIA PVP142-SCB | LLP142 | PVP142



100% waterproof makes any Palio floor an ideal solution for bathrooms and kitchens.



LINOSA PVP148-SCB | LLP148 | PVP148

WOOD

■ 1211.2mm x 169.8mm | ■ 1050mm x 250mm | ■ 1219.2mm x 177.8mm

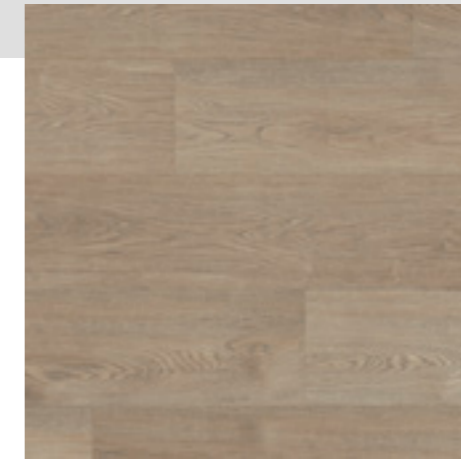

BUDELLI
PVP146-SCB | LLP146 | PVP146



LEVANZO
PVP150-SCB | LLP150 | PVP150



LINOSA
PVP148-SCB | LLP148 | PVP148

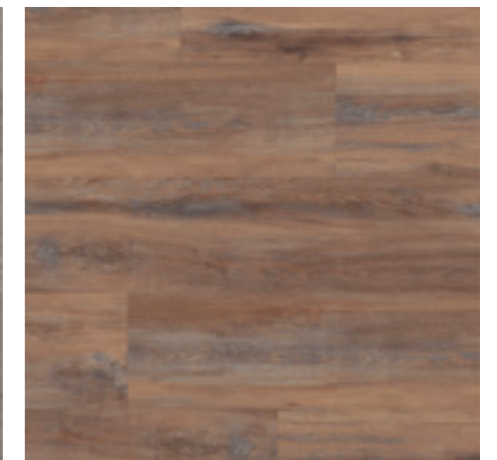

SARDINIA
PVP143-SCB | LLP143 | PVP143



LEVANZO PVP150-SCB | LLP150 | PVP150

STONE

■ 500mm x 610mm

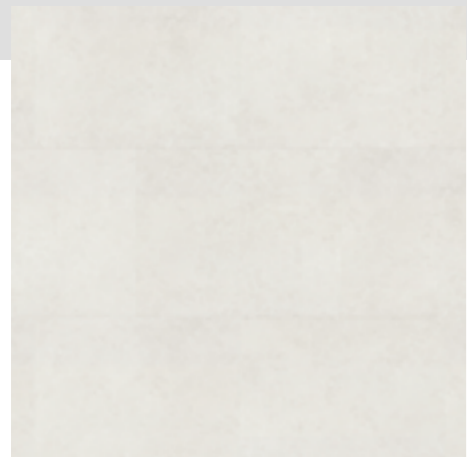

TINO

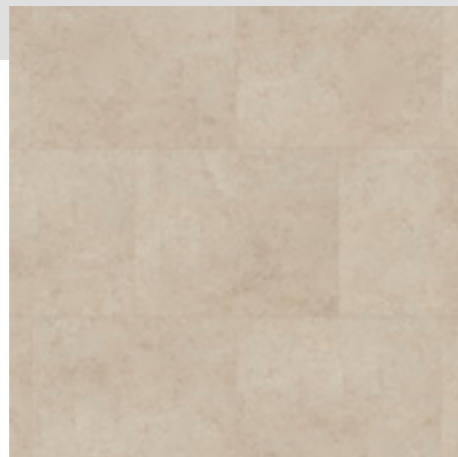

CAPRI

LLT208

LLT209

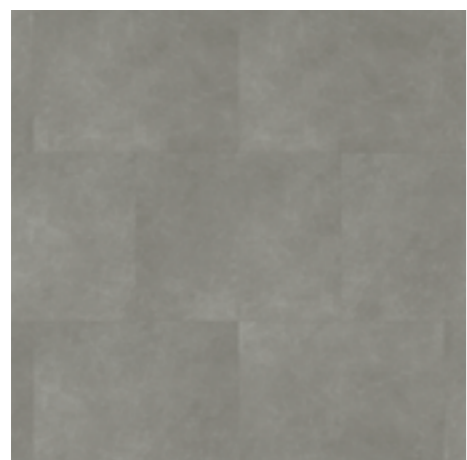

NISIDA



VULCANO

LLT210

LLT211



TINO LLT208



VULCANO LLT211

DESIGN IDEAS

Considering which direction to lay your floor and the pattern you are looking to create will help you to decide which format is right for you.



HAMDEN LLP156 | PVP156



LINOSA LLP148 | PVP148 and LAMPIONE LLP147 | PVP147

WOOD

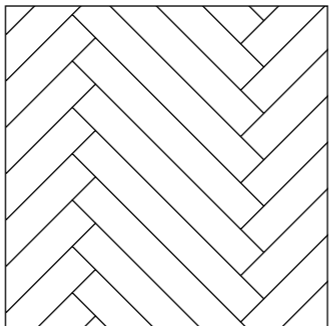

Herringbone

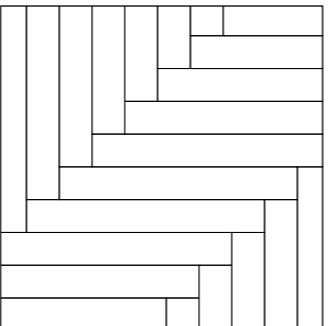

90 degree herringbone

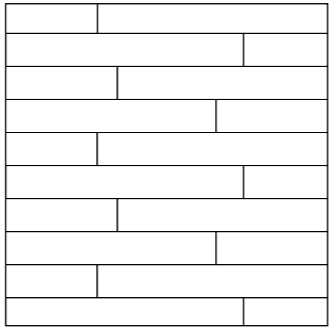

Staggered

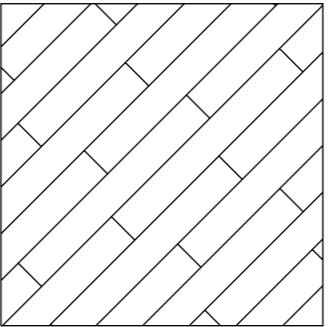

Diagonal

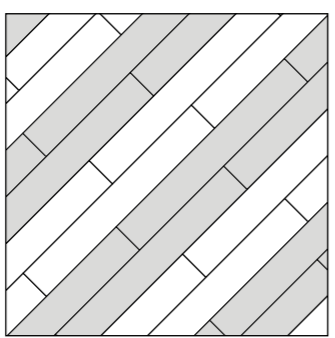

Striped (2-designs)



CAPRI LLT209

STONE

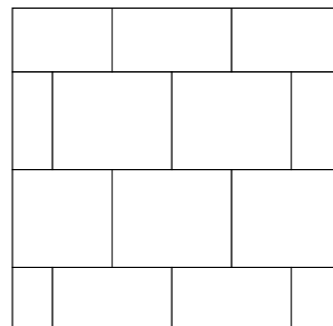

Brick Lay

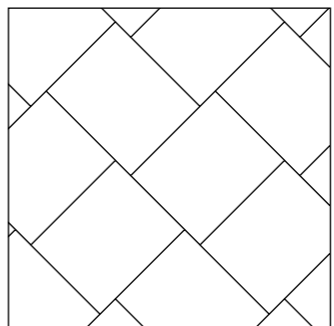

Herringbone

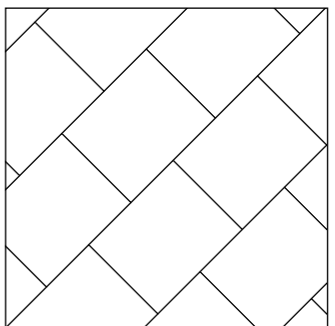

Diagonal

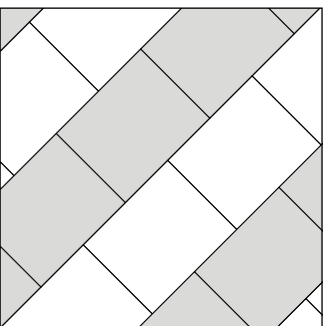

Striped (2-designs)



PALIO RIGID Easy fit installation guidelines



Please refer to palioflooring.com for the full installation instructions.

▶ Scan the QR code to view our helpful 'how to' video's.



SCORE

1. Using a knife and a straight edge, score the plank surface.



SNAP

2. Snap the plank and use a utility knife to fully separate.

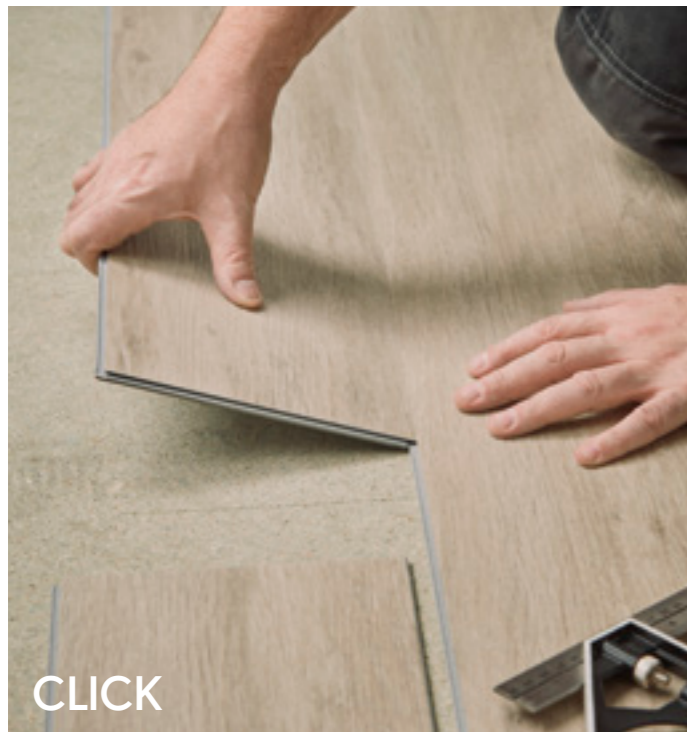

CLICK

3. No need for adhesive, click and lock the planks into place.



4. Continue to fit the rest of the floor, leaving a 5mm expansion gap. Skirting and colour matched scotias are available, see page 38 for more details.

PALIO RIGID Technical specification

	STANDARD	RESULT
SIZE		1211.2mm x 169.8mm
BOX QUANTITY		12 Planks 2.468 m ²
LOCKING SYSTEM*		2G™ angling installation system
THICKNESS	EN ISO 24346	4.5 mm
WEAR LAYER	EN ISO 24340	0.3 mm
SURFACE TREATMENT		PU coating
GUARANTEE**	Residential	20 Years
BEVELLED EDGE		No
MASS PER UNIT AREA	ISO 23997	6575 g/m ²
STANDARDS	EN 16511	Pass (Multilayer Modular Floorcovering Panels)
CLASSIFICATION	ISO 10874 Domestic	23: Domestic Heavy
REACTION TO FIRE	EN 13501-1	Bfl-s1
STAINING RESISTANCE	EN 438-2	Pass (Grade 5)
LIGHT FASTNESS	EN ISO 105-B02	Pass (≥6)
ABRASION RESISTANCE	EN 13329 Annex E	Pass (>1200 cycles)
FURNITURE CHAIR LEG	EN 424	Pass (No visible damage)
DIMENSIONAL STABILITY	BS EN ISO 23999	Pass (<0.25%)
SWELLING	ISO 24336	Pass (0.2%)
ACOUSTIC IMPACT NOISE REDUCTION	EN ISO 10140-1:2016	ΔL _w = 19 dB
INDENTATION - RESIDUAL	ISO 24343-1	Pass (≤ 0.1mm)
IMPACT RESISTANCE	EN 13329 Annex F	Pass (>1800 mm)
THERMAL RESISTANCE	ISO 8302	0.052 m ² K/W Suitable for underfloor heating. Max 27°C
SLIP RESISTANCE***	DIN 51130 EN 13893	R9 DS
LIGHT REFLECTANCE VALUE (LRV)	BS 8493:2008+A1:2010	See separate table
ADHESIVE	None required; please install according to our installation instructions.	
ENVIRONMENTAL	Indoor Air Comfort Floorscore SCS-EC10.3-2014 v4.0 ISO 14001 / ISO 9001	Gold certification Compliant low emitting VOC emissions. Indoor air quality certified; Compliant low emitting VOC emissions. Manufactured to quality and environment management systems standard
RECYCLING		Suitable
PHTHALATE FREE		Yes

PRODUCT	LRV
PVPI42-SCB	26
PVPI43-SCB	20
PVPI44-SCB	34
PVPI45-SCB	27
PVPI46-SCB	27
PVPI47-SCB	38
PVPI48-SCB	21
PVPI49-SCB	46
PVPI50-SCB	25
PVPI52-SCB	35
PVPI53-SCB	32
PVPI56-SCB	34
PVPI57-SCB	42
PVPI61-SCB	52

* 2G™ is a patented technology invented by Välinge Innovation AB. The 2G™ word mark and logo are registered trademarks owned by Välinge Innovation AB and any use of such marks is under license.
 ** Subject to terms. Please see our website.
 *** Slip resistance is measured on freestanding ex-factory product. Slip resistance can be affected by many factors, including but not limited to; product installation and underlayment, surface contamination, use, wear and how the product is maintained. Textural variation along the surface of the product can affect nominal values.



PALIO LOOSELAY Easy fit installation guidelines

Please refer to palioflooring.com for the full installation instructions.

▶ Scan the QR code to view our helpful 'how to' video's.

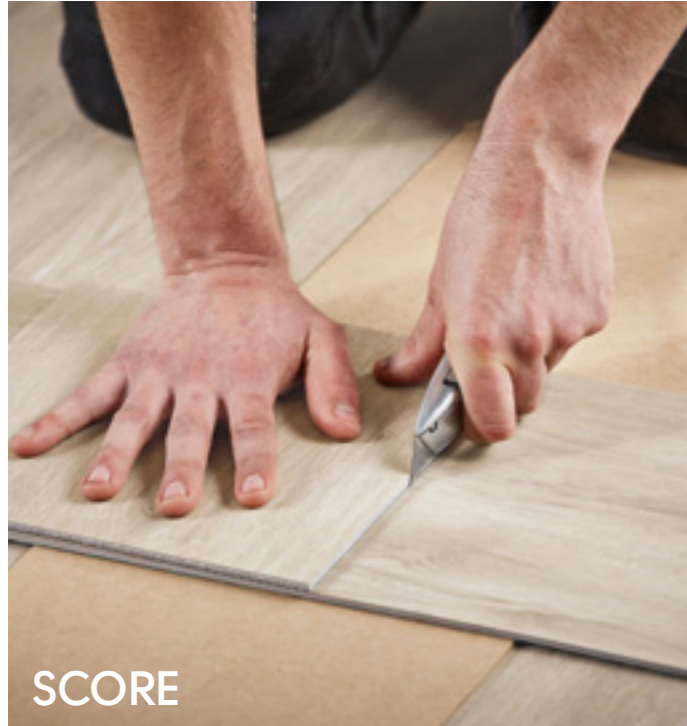

SCORE

1. Using a knife and a straight edge, score the plank/tile surface.

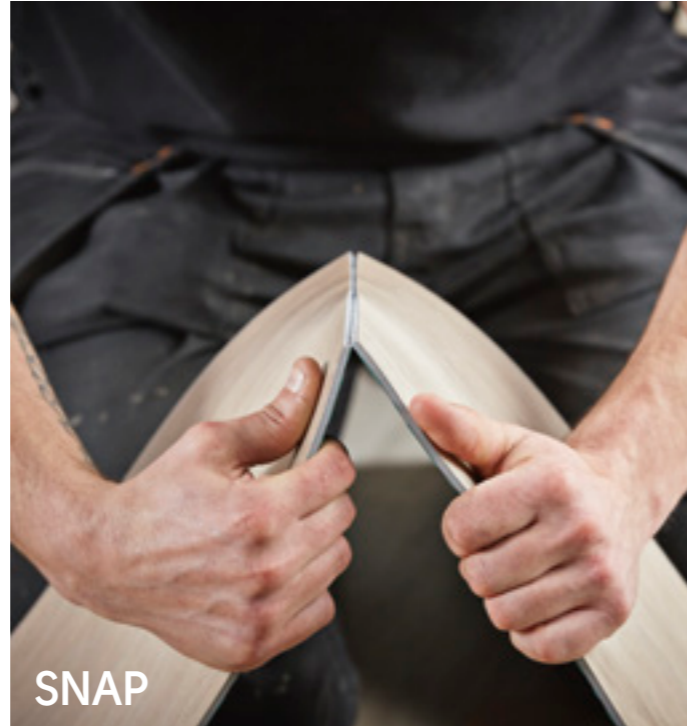

SNAP

2. Snap the plank/tile surface. Use a knife to fully separate the plank/tile.

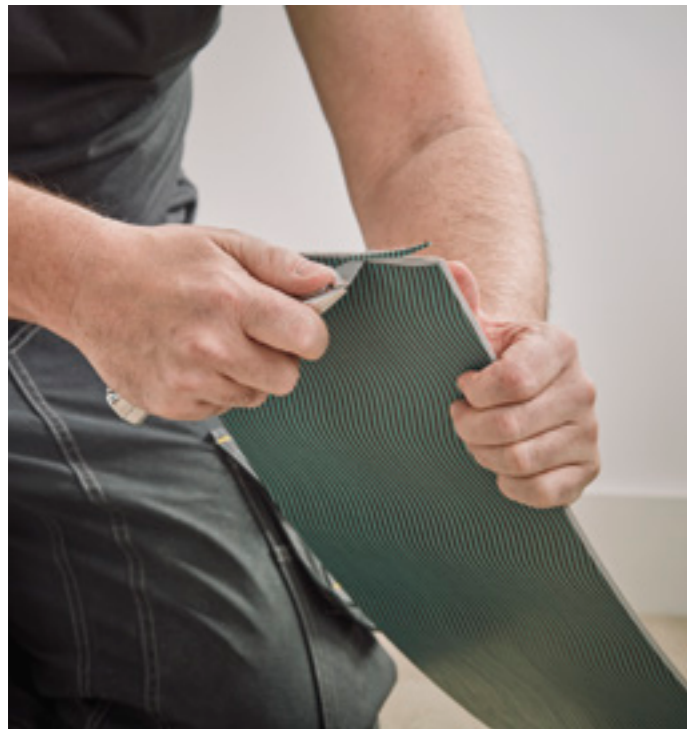

3. Using a knife, chamfer the cut edge to get a symmetrical sloping edge. The plank/tile will fit tight against the wall or another plank/tile.



LAY

4. Lay the planks in place. The friction grip backing will hold the product to the floor. A tackifier around the edge of the room and at thresholds is recommended.**

** For rooms larger than 16m², tackifier is required. See installation guidelines

PALIO LOOSELAY Technical specification

	STANDARD	RESULT
SIZE	EN ISO 24342	Plank: 1050 x 250 mm Tile: 500 x 610 mm
BOX QUANTITY		12 Planks 3.150 m ² 10 Tiles 3.050 m ²
THICKNESS	EN ISO 24346	4.5 mm
WEAR LAYER	EN ISO 24340	0.55 mm
SURFACE TREATMENT		PU coating
GUARANTEE*	Light industrial Commercial Residential	15 years 15 years 20 years
BEVELLED EDGE		No
MASS PER UNIT AREA	EN ISO 23997	7470 g/m ²
STANDARDS	EN 649 / EN ISO 10582	Pass
CLASSIFICATION	EN 685 / EN ISO 10874- Light industrial EN 685 / EN ISO 10874- Commercial EN 685 / EN ISO 10874- Domestic	42: Light industrial general 33: Commercial heavy 23: Domestic heavy
REACTION TO FIRE	EN 13501-1	Bfl-s1
STAINING RESISTANCE	EN ISO 26987 / EN 423	Excellent
LIGHT FASTNESS	EN ISO 105-B02	Pass(≥7)
ABRASION RESISTANCE	EN 649 EN ISO 10582	Group T Type 1
FLEXIBILITY	EN ISO 24344	Pass
DIMENSIONAL STABILITY	EN 434 / EN ISO 23999	Pass (≤0.10%)
ACOUSTIC IMPACT NOISE REDUCTION	EN ISO 717-2 / EN ISO 140-8	ΔL _w = 13 dB
INDENTATION - RESIDUAL	EN 433/EN ISO 24343-1	Pass (≤0.1 mm)
CASTOR CHAIR CONTINUOUS USE	EN 425 / ISO 4918	Pass
THERMAL RESISTANCE	ISO 8302	0.0245 m ² K/W Suitable for underfloor heating. Max 27°C
SLIP RESISTANCE**	DIN 51130 EN 13893	R10 DS
LIGHT REFLECTANCE VALUE (LRV)	BS 8493:2008+A1:2010	See separate table
ADHESIVE	Please install according to our installation instructions.	
ENVIRONMENTAL	Indoor Air Comfort Floorscore SCS-EC10.3-2014 v4.0 ISO 14001 / ISO 9001	Gold certification Compliant low emitting VOC emissions. Indoor air quality certified; Compliant low emitting VOC emissions. Manufactured to quality and environment management systems standard
RECYCLING		Suitable
PHTHALATE FREE		Yes

* Subject to terms. Please see our website.

**Slip resistance is measured on freestanding ex-factory product. Slip resistance can be affected by many factors, including but not limited to; product installation and underlayment, surface contamination, use, wear and how the product is maintained. Textural variation along the surface of the product can affect nominal values.

PRODUCT	LRV
LLP142	26
LLP143	20
LLP144	34
LLP145	27
LLP146	27
LLP147	38
LLP148	21
LLP149	46
LLP150	25
LLP152	35
LLP153	32
LLP156	34
LLP157	42
LLP161	52
LLT208	66
LLT209	44
LLT210	23
LLT211	10

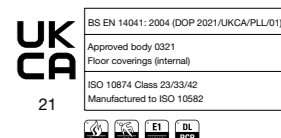
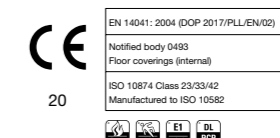

PALIO GLUEDOWN

Fitting a gluedown floor can require greater preparation to ensure a smooth, flat and level surface. The floor is adhered to the subfloor for a longterm solution. Gluedown flooring offers design flexibility but requires installation in accordance with the requirements of BS 8203, DTU 53.2, DIN 18365 (Teil C) or other applicable National Standards and Building Codes for the installation of Resilient Flooring. Please refer to palioflooring.com for our full installation instructions.

DESIGN STRIPS

Add design strips between planks for a ships decking effect, around an island unit to create a feature or, add a border to the edge of your room. The following design strips are available in 3mm, 5mm and 10mm widths.



LINOSA PVP148 WITH DS04 DESIGN STRIP

PALIO GLUEDOWN Technical specification

Please refer to palioflooring.com for the full installation instructions.

	STANDARD	PALIO GLUEDOWN RESULT
SIZE	EN ISO 24342	Plank: 1219.2 mm x 177.8 mm
BOX QUANTITY		22 Planks 4.769 m ²
THICKNESS	EN ISO 24346	2.0 mm
WEAR LAYER	EN ISO 24340	0.3 mm
SURFACE TREATMENT		PU coating
GUARANTEE*	Commercial Residential	10 years 20 years
BEVELLED EDGE		No
MASS PER UNIT AREA	EN ISO 23997	3360 g/m ²
STANDARDS	EN 649/ EN ISO 10582	Pass
CLASSIFICATION	EN 685 / EN ISO 10874 Commercial EN 685 / EN ISO 10874 Domestic	31: Commercial moderate 23: Domestic heavy
REACTION TO FIRE	EN 13501-1	Bfl-s1
STAINING RESISTANCE	EN ISO 26987 / EN 423	Excellent
LIGHT FASTNESS	EN ISO 105-B02	Pass (≥6)
ABRASION RESISTANCE	EN 649 / EN ISO 10582 EN ISO 10582	Group T Type 1
FLEXIBILITY	EN ISO 24344	Pass
DIMENSIONAL STABILITY	EN 434/EN ISO 23999	Pass
ACOUSTIC IMPACT NOISE REDUCTION	EN ISO 717-2 / EN ISO 140-8	ΔL _w = 1 dB
ELECTRICAL BEHAVIOUR BODY VOLTAGE	EN 1815	Pass
INDENTATION - RESIDUAL	EN 433 / EN ISO 24343-1	Pass (≤0.1 mm)
CASTOR CHAIR CONTINUOUS USE	EN 425/ISO 4918	Pass
THERMAL RESISTANCE	EN 12664	0.0107 m ² /K/W Suitable for underfloor heating. Max 27°C
SLIP RESISTANCE**	DIN 51130 EN 13893	R10 DS
LIGHT REFLECTANCE VALUE (LRV)	BS 8493:2008+A1:2010	See separate table
ADHESIVE	Karndean Universal Silane Pressure Sensitive	Yes Yes Yes
ENVIRONMENTAL	Indoor Air Comfort Floorscore SCS-EC10.3-2014 v4.0 ISO 14001 / ISO 9001	Gold certification Compliant low emitting VOC emissions. Indoor air quality certified; Compliant low emitting VOC emissions. Manufactured to quality and environment management systems standard
RECYCLING		Suitable
PHthalate FREE		Yes

PALIO GLUEDOWN	LRV
PVP142	26
PVP143	20
PVP144	34
PVP145	27
PVP146	27
PVP147	38
PVP148	21
PVP149	46
PVP150	25
PVP152	35
PVP153	32
PVP156	34
PVP157	42
PVP161	52

* Subject to terms. Please see our website.

** Slip resistance is measured on freestanding ex-factory product. Slip resistance can be affected by many factors, including but not limited to; product installation and underlayment, surface contamination, use, wear and how the product is maintained. Textural variation along the surface of the product can affect nominal values.









EN 14041: 2004 (DOP 2017/PGluedown/EN/02)
Notified body 0493
Floor coverings (internal)
ISO 10874 Class 23/31
Manufactured to ISO 10582



BS EN 14041: 2004 (DOP 2021/UKCA/PGluedown/01)
Approved body 0521
Floor coverings (internal)
ISO 10874 Class 23/31
Manufactured to ISO 10582

Versilay InstaShield™ is a roll based peel and stick acoustic underlay for fast, easy and mess free installation of Palio Gluedown over existing flat and even subfloors.

Our underlay offers a comprehensive solution to install a Palio Gluedown floor incorporating design strips with minimal floor preparation required. The acoustic properties of Versilay InstaShield™ reduces impact noise transfer by 15dB when combined with Palio Gluedown.

-  **QUICK AND EASY TO INSTALL**
-  **ENABLES PRESERVATION OF EXISTING SUBFLOOR**
-  **ACOUSTIC QUALITIES**
-  **NO EXPANSION GAP**
-  **NO NEED FOR ADHESIVE**
-  **COMPATIBLE WITH UNDERFLOOR HEATING**
-  **CAN BE LAID IN ROOMS WITH 95% RELATIVE HUMIDITY**



INSTALLATION INSTRUCTIONS

📺 Scan the QR code to view our 'how to' video



Tools required - Utility knife with a sharp blade, scissors and hand roller

Step 1.

Roll out the underlay, foil side down (image 1).

The underlay must be laid perpendicular to the intended direction of the floor (image 2).

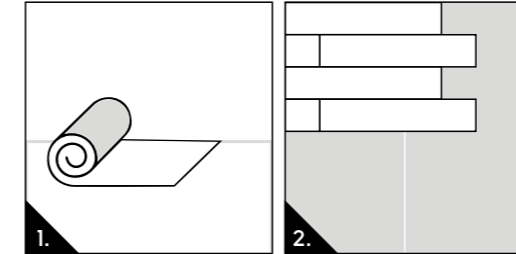

Step 2.

Seams must be tightly butted together ensuring parallel row header joints are 300mm apart. The underlay should remain free of any tape or fixings. Using a pair of scissors, trim the underlay at the perimeter of the room leaving 50mm excess. Create a fold in the underlay at the edge of the room and remove the excess with a knife and straight edge, leaving no gaps between the underlay and the perimeter of the room or fixed objects (image 3). Roll the trimmed ends of the underlay back towards the subfloor, to ensure that it lays flat at the edges (image 4).

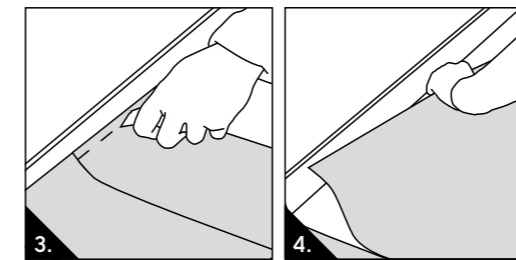

Step 3.

Ensure that planks are carefully positioned so that they overlap the seams in the underlay (image 5). Lay the flooring one row at a time, using the planks as a template to trim the underlying release tape for each row with a utility knife using light pressure (image 6). Carefully position each plank onto the self-adhesive layer on the top of the underlay (image 7), and once correctly positioned use a hand roller to ensure a good bond is achieved.

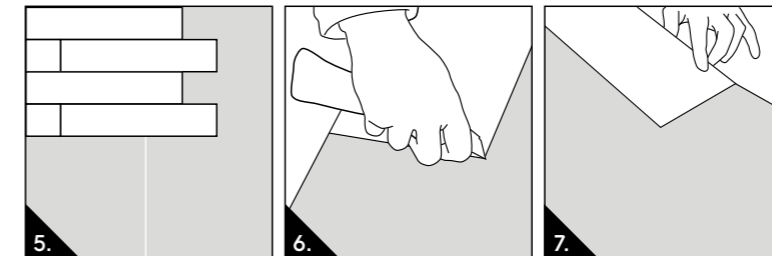

Important

Any underfloor heating must be fully embedded in a screed before laying Versilay InstaShield™ underlay. It is recommended to adhere the underside (foil side) of the underlay to the subfloor when underfloor heating is in situ. This also applies to areas of high solar gain in direct sunlight, as well as 1m beyond the area in all directions and heavy traffic areas too.

COLOUR MATCHED SCOTIAS AND SKIRTING

Our Palio Rigid range requires a suitable edge trim to accommodate an expansion gap around the perimeter of the room. Our collection of waterproof colour matched scotias have been designed to offer a seamless finish to your floor installation.



SCO-PVPI42	SICILIA	
SCO-PVPI43	SARDINIA	
SCO-PVPI44	TAVOLARA	
SCO-PVPI45	TORCELLO	
SCO-PVPI46	BUDELLI	
SCO-PVPI47	LAMPIONE	
SCO-PVPI48	LINOSA	
SCO-PVPI49	PALMARIA	
SCO-PVPI50	LEVANZO	
SCO-PVPI52	WATERBURY	
SCO-PVPI53	BROCKTON	
SCO-PVPI56	HAMDEN	
SCO-PVPI57	BRIDGEPORT	
SCO-PVPI61	SALINA	
SCO-White	WHITE	

Replace old skirting boards with new for a refreshed look or, to cover an expansion gap around the perimeter of the room.

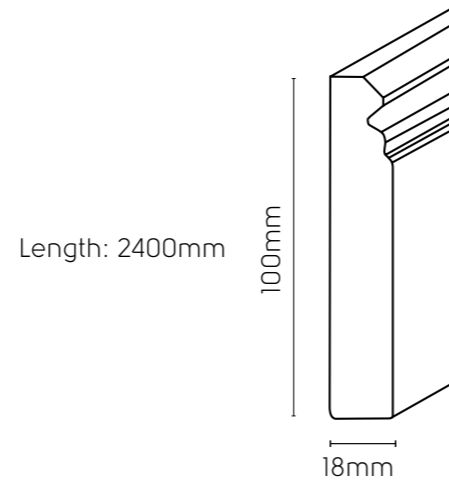

SK100-White	WHITE	
-------------	-------	--

SCOTIA AND SKIRTING INSTALLATION GUIDELINES

For full instructions and guidance on cutting scotia and skirting visit palioflooring.com

Joining straight lengths

Use a mitre block cut the left hand piece at a 45 degree angle and for the right hand piece use the same 45 degree angle as the left hand piece and make the cut.

Scotia

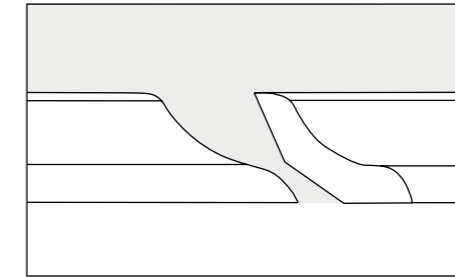

Skirting

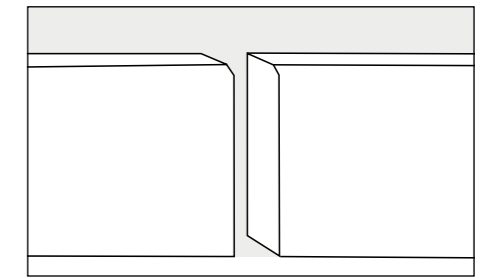

Internal corners

Using a mitre block cut the left hand piece at 45 degrees sawing bottom left to top right. Cut the right hand piece at 45 degrees sawing bottom right to top left.

Scotia

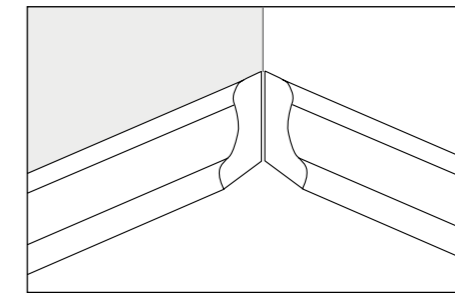

Skirting

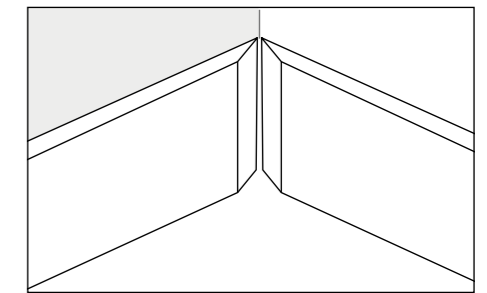

External corners

Using a mitre block, cut the left hand piece at 45 degrees sawing bottom right to top left. For the right hand piece, cut at 45 degrees sawing bottom left to top right.

Scotia

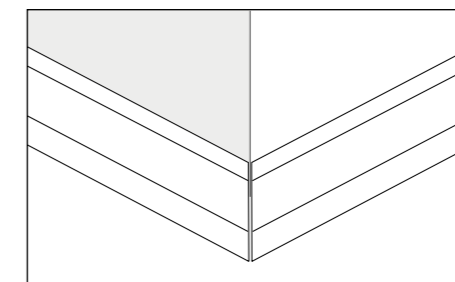

Skirting

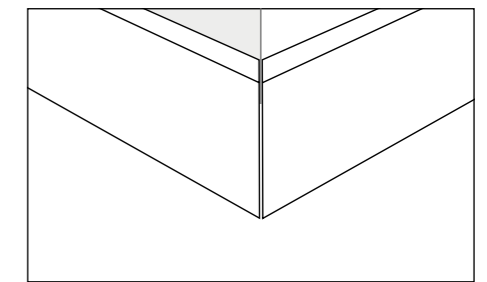

Scotia

Apply cartridge/tube adhesive to the back of your scotia and affix to the wall/skirting.

Use finishing nails every 450mm into the skirting.

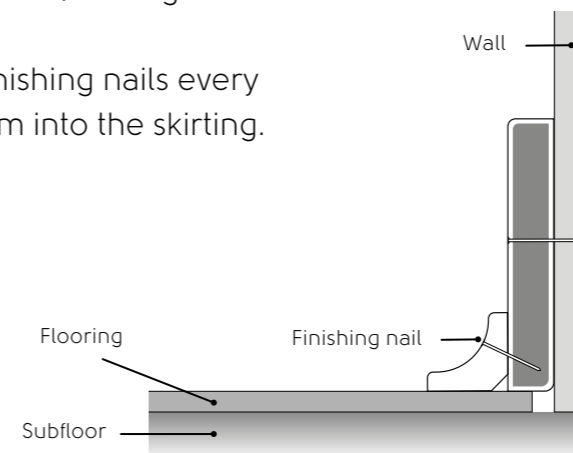

Skirting

Apply cartridge/tube adhesive to the back of the skirting and firmly press against the wall until cured. If required, use 18 gauge fine wire nails every 450mm through the skirting into the wall.

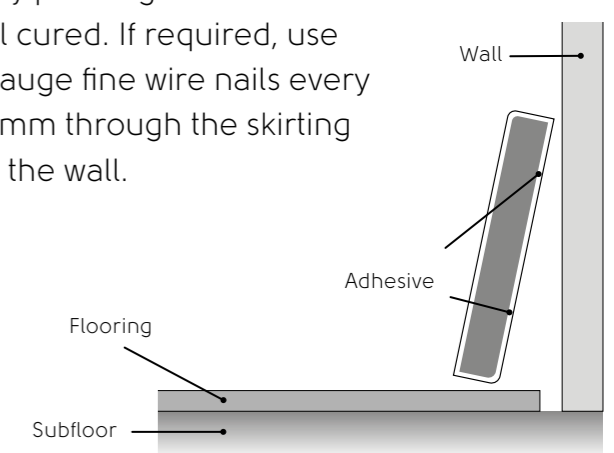



BUDELLI PVP146-SCB | LLP146 | PVP146



CONTACT US...

Crab Apple Way
Evesham
Worcestershire
WR11 1GP
01386 820110
info@palioflooring.com

palioflooring.com



Front cover: BRIDGEPORT PVP157-SCB | LLP157 | PVP157

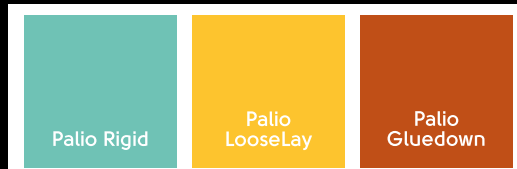

PALTMULBRO4 | KD7345UK 04/23